

Regional & Branch Offices:

NORTH

CHANDIGARH : S.C.O. 10-11-12, 1st Floor, Sec 17 B, Chandigarh - 160017. Tel. 0172 5001548,49

LUCKNOW : Shalimar Square, Office No - 09, 126/31, B. N. Road, Lalbagh, Hazratganj, Lucknow -226001. Tel. 0522 4022324

NOIDA : B9, 1st Floor Sector - 3, Near Bajaj Bhawan, Noida - 201301. Tel. 0120 4848550

DEHRADUN : 57 GDG Tower Adjoining Hotel Calista Patel Nagar Dehradun - 248001, Uttarakhand Tel. 0135 2728758

JAIPUR : B-44 & B-45, Industrial Area, Sudarshanpura Extn., Bais Godam, Jaipur - 302019. Tel. 0141 2216097

EAST

GUWAHATI : 3rd Floor, Purbi Complex, Near Panbazar Flyover, A. T. Road, Guwahati - 781001.

KOLKATA : Unit No-1108, 11th Floor, Godrej Genesis, Plot-XI, Block EP & GP Salt Lake, Sector - V, Kolkata - 700091.

ORISSA : A/2, RCC Building, Ground Floor, Saheed Nagar, Bhubaneswar, Orissa - 751007. Tel. 0674 2549960

PATNA : L-302, 303, Dumraon Palace, 3rd Floor, Fraser Road, Near Dakbangla Crossing, Patna - 800001.

RANCHI : Panchwati Tower Unit No.3, Gr. Floor Harmu Road, Ranchi - 834001 Tel. 0651 2284040

SOUTH

KOCHI : 34/138 C, NH By-Pass Road, Edappally, Kochi - 682024. Tel. 0484 2803285

VISAKHAPATNAM : 3rd Floor, Krishna Enclave, Seethammapeta Main Road, Visakhapatnam - 530 016.

Corporate Office:

POLYCAB INDIA LIMITED (formerly known as 'Polycab Wires Limited')

Polycab House, 771, Mogul Lane, Mahim (W), Mumbai - 400 016, Maharashtra (India) · www.polycab.com

Ph.: +91-22-2432 7070/4, 6735 1400, Fax: +91-22-24327075, Email: enquiry@polycab.com

Switchgear & Switches



Pricelist - w.e.f 1st April 2018



Positive Contact Position Indication:

Red and Green flag indication provided below the knob gives indication of positive electrical ON/OFF contact status irrespective of mounting or knob position even from a distance.



Attractive Label Holder:

Polycab MCB is provided with smoke grey coloured label holder which is positioned on top of the knob for inserting labels for circuit identification and hence reducing maintenance down time.



Large & Dual Terminating Terminal Size:

Polycab MCBs can accommodate cables upto 35sq.mm cross section area thus making it suitable for copper as well as aluminium cables. Both cable and busbar can be terminated at the in-coming.



Bi-stable Din Clip Position:

Convenience of mounting on Din Rail is easy with Polycab MCB. And also, The MCBs can be easily changed from a bank of devices connected by a busbar without disturbing your existing wiring.



Air Circulation:

When two or more poles are placed adjacent to each other, the designed depression in the body cover forms a tunnel and serves as paths for air circulation thus hot air is expelled out faster resulting in reduced body temperatures.



Ease of Clamping:

Input and output clamps on the MCB is provided with combi-head screws which have both the standard slot as well as double head which can be tightened by standard screwdriver as well as Philip screwdriver thus catering to tool availability.



Enhanced Safety:

Finger proof terminals are designed to eliminate accidental contact with live part complying with IP 20 protection category. Install, operate and maintain our MCBs with confidence.



Energy Limiting Class-3:

Rapid arc quenching mechanism in our MCB ensures extinguishing of the arc within quarter cycle (3 to 5 milliseconds) thus minimizing the energy flow through the circuit. This ensures minimizing risk of fire and maximizing the life of your equipment.



Aesthetically Designed with Safety:

Aesthetically designed Flame Retardant body ensures safety in case of accidental fire.



High Quality Contact Tips:

Silver graphite anti-weld contact tips ensure higher life and maximum safety against contact welding thus enhancing safety and life of the device.



Energy Saver:

values upto 70% lesser than specified by IEC/IS; making polyshield MCB one of the most energy efficient MCB.

MINIATURE CIRCUIT BREAKER (MCB)

(In accordance with IS / IEC 60898-1) 240V, 50Hz, 10kA Breaking Capacity



| B - Curve SP MCB | | | C - Curve SP MCB | |
|------------------|------------|------------|------------------|------------|
| Rating (In) | Item Code | MRP/Unit ₹ | Item Code | MRP/Unit ₹ |
| 6A | GMM101P001 | 207/- | GMM201P001 | 218/- |
| 10A | GMM101P002 | 207/- | GMM201P002 | 218/- |
| 16 A | GMM101P003 | 207/- | GMM201P003 | 218/- |
| 20 A | GMM101P004 | 207/- | GMM201P004 | 218/- |
| 25 A | GMM101P005 | 207/- | GMM201P005 | 218/- |
| 32 A | GMM101P006 | 207/- | GMM201P006 | 218/- |
| 40 A | GMM101P007 | 481/- | GMM201P007 | 521/- |
| 63 A | - | - | GMM201P008 | 548/- |



| C - Curve SPN MCB | | | C - Curve DP MCB | |
|-------------------|------------|------------|------------------|------------|
| Rating (In) | Item Code | MRP/Unit ₹ | Item Code | MRP/Unit ₹ |
| 6A | GMM201N001 | 701/- | GMM202P001 | 756/- |
| 10A | GMM201N002 | 701/- | GMM202P002 | 756/- |
| 16 A | GMM201N003 | 701/- | GMM202P003 | 756/- |
| 20 A | GMM201N004 | 701/- | GMM202P004 | 756/- |
| 25 A | GMM201N005 | 701/- | GMM202P005 | 756/- |
| 32 A | GMM201N006 | 701/- | GMM202P006 | 756/- |
| 40 A | GMM201N007 | 991/- | GMM202P007 | 1068/- |
| 63 A | GMM201N008 | 1102/- | GMM202P008 | 1192/- |



| C - Curve TP MCB | | | C - Curve TPN MCB | |
|------------------|------------|------------|-------------------|------------|
| Rating (In) | Item Code | MRP/Unit ₹ | Item Code | MRP/Unit ₹ |
| 6A | GMM203P001 | 1150/- | GMM203N001 | 1483/- |
| 10A | GMM203P002 | 1150/- | GMM203N002 | 1483/- |
| 16 A | GMM203P003 | 1150/- | GMM203N003 | 1483/- |
| 20 A | GMM203P004 | 1150/- | GMM203N004 | 1483/- |
| 25 A | GMM203P005 | 1150/- | GMM203N005 | 1483/- |
| 32 A | GMM203P006 | 1150/- | GMM203N006 | 1483/- |
| 40 A | GMM203P007 | 1716/- | GMM203N007 | 2102/- |
| 63 A | GMM203P008 | 1865/- | GMM203N008 | 2260/- |



| C - Curve FP MCB | | |
|------------------|------------|------------|
| Rating (In) | Item Code | MRP/Unit ₹ |
| 6A | GMM204P001 | 1639/- |
| 10A | GMM204P002 | 1639/- |
| 16 A | GMM204P003 | 1639/- |
| 20 A | GMM204P004 | 1639/- |
| 25 A | GMM204P005 | 1639/- |
| 32 A | GMM204P006 | 1639/- |
| 40 A | GMM204P007 | 2203/- |
| 63 A | GMM204P008 | 2369/- |

Note: Packing (Primary / Secondary / Master): SP-1 / 12 / 108;
DP-1 / 6 / 54; TP-1 / 4 / 36; FP-1 / 3 / 27.

MINIATURE CIRCUIT BREAKER (MCB)

(In accordance with IS / IEC 60898-1) 240V, 50Hz, 10kA Breaking Capacity



| C - Curve SP MCB | | | C - Curve DP MCB | |
|------------------|------------|------------|------------------|------------|
| Rating (In) | Item Code | MRP/Unit ₹ | Item Code | MRP/Unit ₹ |
| 0.5A | GMM201P012 | 347/- | GMM202P012 | 1190/- |
| 1A | GMM201P013 | 347/- | GMM202P013 | 1190/- |
| 2A | GMM201P014 | 347/- | GMM202P014 | 1190/- |
| 3A | GMM201P015 | 347/- | GMM202P015 | 1190/- |
| 4A | GMM201P016 | 347/- | GMM202P016 | 1190/- |
| 5A | GMM201P017 | 347/- | GMM202P017 | 1190/- |

| C - Curve TP MCB | | | C - Curve FP MCB | |
|------------------|------------|------------|------------------|------------|
| Rating (In) | Item Code | MRP/Unit ₹ | Item Code | MRP/Unit ₹ |
| 0.5A | GMM203P012 | 1800/- | GMM204P012 | 2200/- |
| 1A | GMM203P013 | 1800/- | GMM204P013 | 2200/- |
| 2A | GMM203P014 | 1800/- | GMM204P014 | 2200/- |
| 3A | GMM203P015 | 1800/- | GMM204P015 | 2200/- |
| 4A | GMM203P016 | 1800/- | GMM204P016 | 2200/- |
| 5A | GMM203P017 | 1800/- | GMM204P017 | 2200/- |



| D - Curve SP MCB | | | D - Curve SP MCB | | |
|------------------|------------|------------|------------------|------------|------------|
| Rating (In) | Item Code | MRP/Unit ₹ | Rating (In) | Item Code | MRP/Unit ₹ |
| 6A | GMM301P001 | 394/- | 6A | GMM301P001 | 394/- |
| 10A | GMM301P002 | 394/- | 10A | GMM301P002 | 394/- |
| 16A | GMM301P003 | 394/- | 16A | GMM301P003 | 394/- |
| 20A | GMM301P004 | 394/- | 20A | GMM301P004 | 394/- |
| 25A | GMM301P005 | 394/- | 25A | GMM301P005 | 394/- |
| 32A | GMM301P006 | 394/- | 32A | GMM301P006 | 394/- |
| 40A | GMM301P007 | 599/- | 40A | GMM301P007 | 599/- |
| 63A | GMM301P008 | 602 | 63A | GMM301P008 | 602 |

| D - Curve TP MCB | | | D - Curve FP MCB | | |
|------------------|------------|------------|------------------|------------|------------|
| Rating (In) | Item Code | MRP/Unit ₹ | Rating (In) | Item Code | MRP/Unit ₹ |
| 6A | GMM303P001 | 1318/- | 6A | GMM304P001 | 1759/- |
| 10A | GMM303P002 | 1318/- | 10A | GMM304P002 | 1759/- |
| 16A | GMM303P003 | 1318/- | 16A | GMM304P003 | 1759/- |
| 20A | GMM303P004 | 1318/- | 20A | GMM304P004 | 1759/- |
| 25A | GMM303P005 | 1318/- | 25A | GMM304P005 | 1759/- |
| 32A | GMM303P006 | 1318/- | 32A | GMM304P006 | 1759/- |
| 40A | GMM303P007 | 1980/- | 40A | GMM304P007 | 2490/- |
| 63A | GMM303P008 | 2006/- | 63A | GMM304P008 | 2540/- |

Note: Packing (Primary / Secondary / Master): SP-1 / 12 / 108;
DP-1 / 6 / 54; TP-1 / 4 / 36; FP-1 / 3 / 27.

MINIATURE CIRCUIT BREAKER (MCB) for DC Installations
(In accordance with IEC 60947-2) 250Vdc per pole, 6kA Breaking Capacity

| SP MCB | | |
|-------------|------------|------------|
| Rating (In) | Item Code | MRP/Unit ₹ |
| 0.5A | GMM401P012 | 670/- |
| 1A | GMM401P013 | 670/- |
| 2A | GMM401P014 | 670/- |
| 3A | GMM401P015 | 670/- |
| 4A | GMM401P016 | 670/- |
| 5A | GMM401P017 | 670/- |
| 6A | GMM401P001 | 640/- |
| 10A | GMM401P002 | 640/- |
| 16A | GMM401P003 | 640/- |
| 20A | GMM401P004 | 640/- |
| 25A | GMM401P005 | 640/- |
| 32A | GMM401P006 | 640/- |
| 40A | GMM401P007 | 788/- |
| 50A | GMM401P018 | 788/- |
| 63A | GMM401P008 | 788/- |



MINIATURE CIRCUIT BREAKER (MCB) for DC Installations
(In accordance with IEC 60947-2) 250Vdc per pole, 6kA Breaking Capacity

| DP | | |
|-------------|------------|------------|
| Rating (In) | Item Code | MRP/Unit ₹ |
| 40 A | GMS502P001 | 455/- |
| 63 A | GMS502P002 | 604/- |
| 80 A | GMS502P003 | 778/- |
| 100 A | GMS502P004 | 801/- |
| 125 A | GMS502P005 | 885/- |



MINIATURE CIRCUIT BREAKER (MCB) for DC Installations
(In accordance with IEC 60947-2) 250Vdc per pole, 6kA Breaking Capacity

| DP MCB | | | FP MCB | | |
|-------------|------------|------------|-------------|------------|------------|
| Rating (In) | Item Code | MRP/Unit ₹ | Rating (In) | Item Code | MRP/Unit ₹ |
| 0.5A | GMM402P012 | 1400/- | 0.5A | GMM404P012 | 2900/- |
| 1A | GMM402P013 | 1400/- | 1A | GMM404P013 | 2900/- |
| 2A | GMM402P014 | 1400/- | 2A | GMM404P014 | 2900/- |
| 3A | GMM402P015 | 1400/- | 3A | GMM404P015 | 2900/- |
| 4A | GMM402P016 | 1400/- | 4A | GMM404P016 | 2900/- |
| 5A | GMM402P017 | 1400/- | 5A | GMM404P017 | 2900/- |
| 6A | GMM402P001 | 1350/- | 6A | GMM404P001 | 2800/- |
| 10A | GMM402P002 | 1350/- | 10A | GMM404P002 | 2800/- |
| 16A | GMM402P003 | 1350/- | 16A | GMM404P003 | 2800/- |
| 20A | GMM402P004 | 1350/- | 20A | GMM404P004 | 2800/- |
| 25A | GMM402P005 | 1350/- | 25A | GMM404P005 | 2800/- |
| 32A | GMM402P006 | 1350/- | 32A | GMM404P006 | 2800/- |
| 40A | GMM402P007 | 1700/- | 40A | GMM404P007 | 3600/- |
| 50A | GMM402P018 | 1700/- | 50A | GMM404P018 | 3600/- |
| 63A | GMM402P008 | 1700/- | 63A | GMM404P008 | 3600/- |



Note: Packing (Primary / Secondary / Master): SP-1 / 12 / 108;
DP-1 / 6 / 54; TP-1 / 4 / 36; FP-1 / 3 / 27.

ISOLATORS
(In accordance with IS/IEC 60947-3)

| SP | | |
|-------------|------------|------------|
| Rating (In) | Item Code | MRP/Unit ₹ |
| 40 A | GMS501P001 | 318/- |
| 63 A | GMS501P002 | 376/- |



Note: Packing (Primary / Secondary / Master): SP-1 / 12 / 108; DP-1 / 6 / 54.



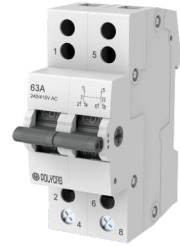

MCB CHANGEOVER SWITCH
(In accordance with IS/IEC 60947-3)

| DP | | |
|-------------|-----------|------------|
| Rating (In) | Item Code | MRP/Unit ₹ |

| | | |
|-----|------------|------|
| 25A | GMC102P001 | 700 |
| 40A | GMC102P002 | 990 |
| 63A | GMC102P003 | 1230 |

| FP | | |
|-------------|-----------|------------|
| Rating (In) | Item Code | MRP/Unit ₹ |

| | | |
|-----|------------|------|
| 25A | GMC104P001 | 1400 |
| 40A | GMC104P002 | 1980 |
| 63A | GMC104P003 | 2460 |

Note: Packing (Primary / Secondary / Master): SP- 1N / 6N / 54 N / FP- 1N / 3N / 27N

RESIDUAL CURRENT CIRCUIT BREAKER (RCCB)

| DP | | | |
|-------------|-------------|-----------|------------|
| Rating (In) | Sensitivity | Item Code | MRP/Unit ₹ |

| | | | |
|-----|-------|------------|--------|
| 25A | 30mA | GMR602P003 | 2770/- |
| | 100mA | GMR602P009 | 2770/- |
| | 300mA | GMR602P015 | 2821/- |
| 40A | 30mA | GMR602P005 | 2872/- |
| | 100mA | GMR602P011 | 2872/- |
| | 300mA | GMR602P017 | 2975/- |
| 63A | 30mA | GMR602P006 | 3487/- |
| | 100mA | GMR602P012 | 3487/- |
| | 300mA | GMR602P018 | 3590/- |

| FP | | | |
|-------------|-------------|-----------|------------|
| Rating (In) | Sensitivity | Item Code | MRP/Unit ₹ |

| | | | |
|-----|-------|------------|--------|
| 25A | 30mA | GMR604P003 | 3282/- |
| | 100mA | GMR604P009 | 3282/- |
| | 300mA | GMR604P015 | 3334/- |
| 40A | 30mA | GMR604P005 | 3385/- |
| | 100mA | GMR604P011 | 3385/- |
| | 300mA | GMR604P017 | 3436/- |
| 63A | 30mA | GMR604P006 | 3795/- |
| | 100mA | GMR604P012 | 3795/- |
| | 300mA | GMR604P018 | 3846/- |

Note: Packing (Primary / Secondary / Master): DP- 1 / 6 / 36; FP- 1 / 3 / 18.

RESIDUAL CURRENT CIRCUIT BREAKER WITH OVER CURRENT PROTECTION (RCBO)

| DP | | | |
|-------------|-------------|-----------|------------|
| Rating (In) | Sensitivity | Item Code | MRP/Unit ₹ |

| | | | |
|-----|-------|------------|--------|
| 6A | 30mA | GMB101N001 | 3250/- |
| | 100mA | GMB201N001 | 3444/- |
| | 300mA | GMB301N001 | 3444/- |
| 10A | 30mA | GMB101N002 | 3250/- |
| | 100mA | GMB201N002 | 3444/- |
| | 300mA | GMB301N002 | 3444/- |
| 16A | 30mA | GMB101N003 | 3250/- |
| | 100mA | GMB201N003 | 3444/- |
| | 300mA | GMB301N003 | 3444/- |
| 20A | 30mA | GMB101N004 | 3250/- |
| | 100mA | GMB201N004 | 3444/- |
| | 300mA | GMB301N004 | 3444/- |
| 25A | 30mA | GMB101N005 | 3250/- |
| | 100mA | GMB201N005 | 3444/- |
| | 300mA | GMB301N005 | 3444/- |
| 32A | 30mA | GMB101N006 | 3250/- |
| | 100mA | GMB201N006 | 3444/- |
| | 300mA | GMB301N006 | 3444/- |
| 40A | 30mA | GMB101N007 | 3347/- |
| | 100mA | GMB201N007 | 3735/- |
| | 300mA | GMB301N007 | 3735/- |
| 63A | 30mA | GMB101N008 | 4317/- |
| | 100mA | GMB201N008 | 4511/- |
| | 300mA | GMB301N008 | 4511/- |

Note: Packing (Primary / Secondary / Master): DP-1 / NA / 12.



RESIDUAL CURRENT CIRCUIT BREAKER WITH OVER CURRENT PROTECTION (RCBO)

| Rating (In) | Sensitivity | FP | |
|-------------|-------------|------------|------------|
| | | Item Code | MRP/Unit ₹ |
| 6A | 30mA | GMB103N001 | 4123 |
| | 100mA | GMB203N001 | 4220 |
| | 300mA | GMB303N001 | 4220 |
| 10A | 30mA | GMB103N002 | 4123 |
| | 100mA | GMB203N002 | 4220 |
| | 300mA | GMB303N002 | 4220 |
| 16A | 30mA | GMB103N003 | 4123 |
| | 100mA | GMB203N003 | 3444 |
| | 300mA | GMB303N003 | 4220 |
| 20A | 30mA | GMB103N004 | 4123 |
| | 100mA | GMB203N004 | 4220 |
| | 300mA | GMB303N004 | 4220 |
| 25A | 30mA | GMB103N005 | 4123 |
| | 100mA | GMB203N005 | 4220 |
| | 300mA | GMB303N005 | 4220 |
| 32A | 30mA | GMB103N006 | 4123 |
| | 100mA | GMB203N006 | 4220 |
| | 300mA | GMB303N006 | 4220 |
| 40A | 30mA | GMB103N007 | 4220 |
| | 100mA | GMB203N007 | 4317 |
| | 300mA | GMB303N007 | 4317 |
| 63A | 30mA | GMB103N008 | 4923 |
| | 100mA | GMB203N008 | 4996 |
| | 300mA | GMB303N008 | 4996 |



Note: Packing (Primary / Secondary / Master): 1 / NA / 8

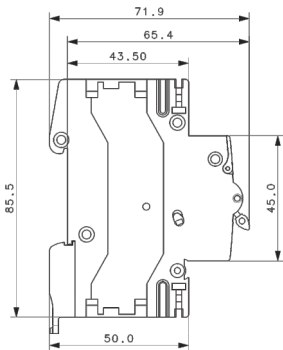

Dimension details of MCB's / Isolators :

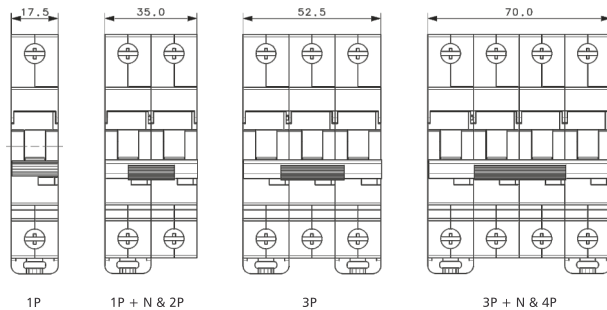

Salient Features

- As per IS 13032/ 8623
- Aesthetically superior to suit the interiors.
- Suitable for flush and surface mounting.
- Ready to use DBs – provided with 100A phase bus-bar, Neutral bar, Cement spill Protector, Earth bar and Interconnecting wires as standard accessories.
- Provided with removable top and bottom gland plates With adequate knockouts for easy wiring.
- DBs made up of CRCA sheet steel & powder coated with RAL 9003 fine white shade.

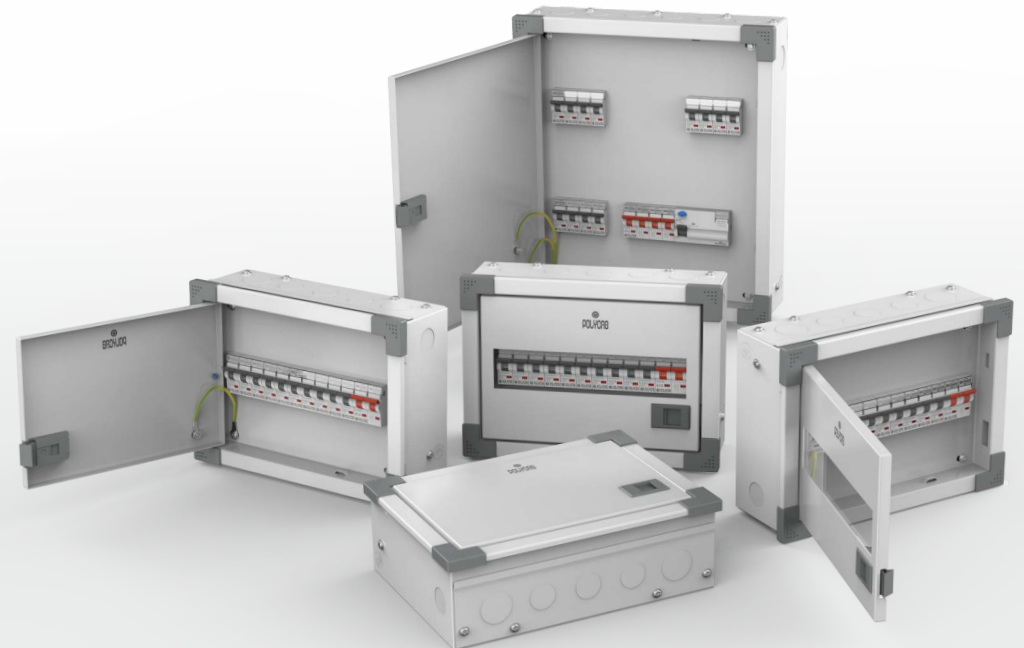



MCB ENCLOSURE

(In accordance with IS 13032, IS 8623, IEC / BSEN 61439-3)
RAL - 9003 fine white texture

MCB Enclosure (Cut-Out)
In Sheet Steel, Suitable for 2P/4P Devices

| No. Of Ways | No. of Poles | Item Code | MRP/Unit ₹ |
|-------------|--------------|------------|------------|
| 2W | DP | GPDSN10002 | 371/- |
| 4W | FP | GPDTN10002 | 436/- |



PLUG & SOCKETS

(In accordance with IS 13032, IS 8623, IEC / BSEN 61439-3)
RAL - 9003 fine white texture

Plug & Socket Board, With Metal Plug & Socket, 1P+N/3P & Earth

| Rating | No. of Poles | Item Code | MRP/Unit ₹ |
|--------|--------------|------------|------------|
| 20A | SP | GPDPS10006 | 709/- |
| 20A | DP | GPDPS10004 | 970/- |
| 20A | TP | GPDPS10005 | 1744/- |
| 30A | TP | GPDPS20003 | 2698/- |



SPN DISTRIBUTION BOARD

(In accordance with IS 13032, IS 8623, IEC / BSEN 61439-3)
RAL - 9003 fine white texture IP 30 - Single Door DB

SPN Distribution Board (Suitable for DP Incoming and SP Outgoing)

| No. Of Ways | Item Code Single Door | MRP/Unit ₹ |
|-------------|-----------------------|------------|
| 4W | GPDSN10016 | 937/- |
| 6W | GPDSN10017 | 1008/- |
| 8W | GPDSN10018 | 1068/- |
| 12W | GPDSN10019 | 1493/- |
| 16W | GPDSN10020 | 1908/- |



TPN DISTRIBUTION BOARD

(In accordance with IS 13032, IS 8623, IEC / BSEN 61439-3)
RAL - 9003 fine white texture, IP 30 - Single Door DB

TP&N Distribution Board (Suitable for FP Incoming and SP Outgoing)

| No. Of Ways | I/C + O/G Ways | Item Code Single Door | MRP/Unit ₹ |
|-------------|----------------|-----------------------|------------|
| 4W | 4 + 12 | GPDTN10031 | 2671/- |
| 4W | 8 + 12 | GPDTN10032 | 2943/- |
| 6W | 8 + 18 | GPDTN10033 | 3188/- |
| 8W | 8 + 24 | GPDTN10034 | 3706/- |
| 12W | 8 + 36 | GPDTN10030 | 5150/- |

SPN DISTRIBUTION BOARD

RAL - 9003 fine white texture IP 42 - Double Door DB

SPN Distribution Board (Suitable for DP Incoming and SP Outgoing)

| No. Of Ways | Item Code Double Door | MRP/Unit ₹ |
|-------------|-----------------------|------------|
| 4W | GPDSN20016 | 1308/- |
| 6W | GPDSN20012 | 1537/- |
| 8W | GPDSN20017 | 1771/- |
| 12W | GPDSN20018 | 2153/- |
| 16W | GPDSN20019 | 2889/- |

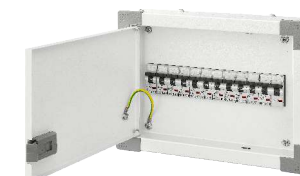

Note: SPN TV TELEPHONE DB AVAILABLE ON REQUEST

TPN DISTRIBUTION BOARD

RAL - 9003 fine white texture IP 42 - Double Door DB

TPN Distribution Board (Suitable for FP Incoming and SP Outgoing)

| No. Of Ways | I/C + O/G Ways | Item Code Double Door | MRP/Unit ₹ |
|-------------|----------------|-----------------------|------------|
| 4W | 4 + 12 | GPDTN20064 | 3379/- |
| 4W | 8 + 12 | GPDTN20065 | 3537/- |
| 6W | 8 + 18 | GPDTN20066 | 4360/- |
| 8W | 8 + 24 | GPDTN20067 | 5396/- |
| 12W | 8 + 36 | GPDTN20068 | 8284/- |



Note: TPN TV TELEPHONE DB AVAILABLE ON REQUEST

SPN ACRYLIC DISTRIBUTION BOARD

RAL - 9003 fine white texture IP 42 - Double Door DB

SPN Distribution Board (Suitable for DP Incoming and SP Outgoing)

| No. Of Ways | Item Code Double Door | MRP/Unit ₹ |
|-------------|-----------------------|------------|
| 4W | GPDSN30006 | 1439/- |
| 6W | GPDSN30007 | 1690/- |
| 8W | GPDSN30008 | 1951/- |
| 12W | GPDSN30009 | 2369/- |
| 16W | GPDSN30010 | 3177/- |



TPN ACRYLIC DISTRIBUTION BOARD

RAL - 9003 fine white texture IP 42 - Double Door DB

TPN Distribution Board (Suitable for FP Incoming and SP Outgoing)

| No. Of Ways | I/C + O/G Ways | Item Code Single Door | MRP/Unit ₹ |
|-------------|----------------|-----------------------|------------|
| 4W | 4 + 12 | GPDTN30006 | 3886/- |
| 4W | 8 + 12 | GPDTN30007 | 4068/- |
| 6W | 8 + 18 | GPDTN30008 | 5014/- |
| 8W | 8 + 24 | GPDTN30009 | 6205/- |
| 12W | 8 + 36 | GPDTN30010 | 9527/- |





TPN VERTICAL DISTRIBUTION BOARD

(In accordance with IS 13032, IS 8623, IEC / BSEN 61439-3)
RAL - 9003 fine white texture, IP 42 - Double Door DB

TPN Vertical Distribution Board (Suitable for FP Incoming and SP / TP Outgoing)

| No. Of Ways | I/C + O/G Ways | Item Code Double Door | MRP/Unit ₹ |
|-------------|----------------|-----------------------|------------|
| 4W | 8+12 | GPDTN20069 | 8666/- |
| 6W | 8+18 | GPDTN20070 | 9810/- |
| 8W | 8+24 | GPDTN20071 | 10900/- |
| 12W | 8+36 | GPDTN20072 | 15369/- |

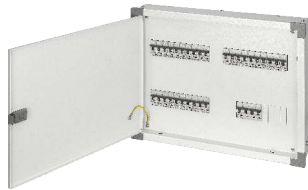

TPN PPI HORIZONTAL DISTRIBUTION BOARD

(In accordance with IS 13032, IS 8623, IEC / BSEN 61439-3)
RAL - 9003 fine white texture, IP 42 - Double Door DB

TPN Distribution Board, Per Phase Isolated Neutral (Suitable for FP Incoming and SP Outgoing)

| No. Of Ways | I/C + O/G Ways | Item Code Double Door | MRP/Unit ₹ |
|-------------|----------------|-----------------------|------------|
| 4W | 8+6+12 | GPDTN20077 | 5150/- |
| 6W | 8+6+18 | GPDTN20078 | 7358/- |
| 8W | 8+6+24 | GPDTN20079 | 9701/- |
| 12W | 8+6+36 | GPDTN20080 | 12862/- |



TPN PPI VERTICAL DISTRIBUTION BOARD

(In accordance with IS 13032, IS 8623, IEC / BSEN 61439-3)
RAL - 9003 fine white texture, IP 42 - Double Door DB

TPN Distribution Board, Per Phase Isolated Neutral (Suitable for FP Incoming and SP Outgoing)

| No. Of Ways | I/C + O/G Ways | Item Code Double Door | MRP/Unit ₹ |
|-------------|----------------|-----------------------|------------|
| 4W | 8+6+12 | GPDTN20046 | 5667/- |
| 6W | 8+6+18 | GPDTN20047 | 8093/- |
| 8W | 8+6+24 | GPDTN20048 | 10671/- |
| 12W | 8+6+36 | GPDTN20049 | 14148/- |



FLEXY TIER DISTRIBUTION BOARD

Flexibility of Choosing Incomer & Outgoing as per your requirement RAL - 9003 fine white texture IP 42 - Double Door DB

Distribution Board, With Total Installation Flexibility

| No. Of Ways | No of Modules | Item Code Double Door | MRP/Unit ₹ |
|-----------------|---------------|-----------------------|------------|
| 2 Row of 12 Mod | 24 | GPDTN20052 | 2834/- |
| 3 Row of 12 Mod | 36 | GPDTN20053 | 3815/- |
| 4 Row of 10 Mod | 40 | GPDTN20054 | 4578/- |
| 4 Row of 14 Mod | 56 | GPDTN20055 | 5396/- |

TPN PHASE SELECTOR

(In accordance with IS 13032, IS 8623, IEC / BSEN 61439-3)
RAL - 9003 fine white texture, IP 42 - Double Door DB

Phase Selector Distribution Board, Vertical Config. Suitable for 8 way incomer and SP Outgoing with Rotary Switches (for Manual Phase Selection) and indicating Light, Duly Wired

| Selector Rating | No. Of Ways | Item Code Single Door | MRP/Unit ₹ | Item Code Double Door | MRP/Unit ₹ |
|-----------------|-------------|-----------------------|------------|-----------------------|------------|
| 40 A | 4 W | GPDTN10035 | 9892/- | GPDTN30021 | 11227/- |
| 40 A | 6 W | GPDTN10037 | 10137/- | GPDTN30023 | 11990/- |
| 40 A | 8 W | GPDTN10039 | 11173/- | GPDTN30025 | 12971/- |
| 63 A | 4 W | GPDTN10036 | 11227/- | GPDTN30022 | 12862/- |
| 63 A | 6 W | GPDTN10038 | 11990/- | GPDTN30024 | 13625/- |
| 63 A | 8 W | GPDTN10040 | 12971/- | GPDTN30026 | 14606/- |



TPN DISTRIBUTION BOARD, 7 SEGMENT

(In accordance with IS 13032, IS 8623, IEC / BSEN 61439-3)
RAL - 9003 fine white texture, IP 42 - Double Door DB

TPN Distribution Board, Special Purpose, 7 Segment, Per Phase Isolated Neutral (Suitable for FP Incoming and SP Outgoing with Provision of DP RCCB Protection)

| No. Of Ways | I/C + O/G Ways | Item Code Double Door | MRP/Unit ₹ |
|-------------|----------------|-----------------------|------------|
| 4W | 8+6+12 | GPDTN20073 | 7374/- |
| 6W | 8+6+18 | GPDTN20074 | 8993/- |
| 8W | 8+6+24 | GPDTN20075 | 11936/- |
| 12W | 8+6+36 | GPDTN20076 | 14334/- |



TPN DISTRIBUTION BOARD, 8 SEGMENT

(In accordance with IS 13032, IS 8623, IEC / BSEN 61439-3)
RAL - 9003 fine white texture, IP 42 - Double Door DB

TPN Distribution Board, Special Purpose, 8 Segment, Per Phase Isolated Neutral (Suitable for FP Incoming and SP Outgoing with Provision of DP RCCB Protection)

| No. Of Ways | Item Code Double Door | MRP/Unit ₹ |
|-------------|-----------------------|------------|
| 4W | GPDTN20083 | 7670/- |
| 6W | GPDTN20084 | 9352/- |
| 8W | GPDTN20085 | 12414/- |
| 12W | GPDTN20086 | 14908/- |



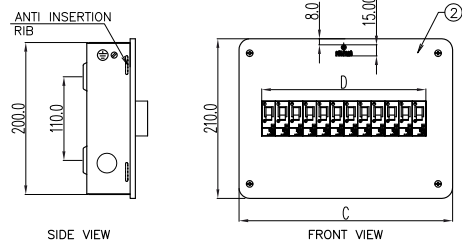

**GA DRAWINGS FOR -
SPN DB: IP-30 (Single Door)**

| WAY | A | B | C | D |
|-----|-----|-----|-----|-----|
| 4 | 132 | 62 | 142 | 72 |
| 6 | 168 | 98 | 178 | 108 |
| 8 | 204 | 134 | 214 | 144 |
| 12 | 276 | 206 | 286 | 216 |
| 16 | 348 | 278 | 358 | 288 |

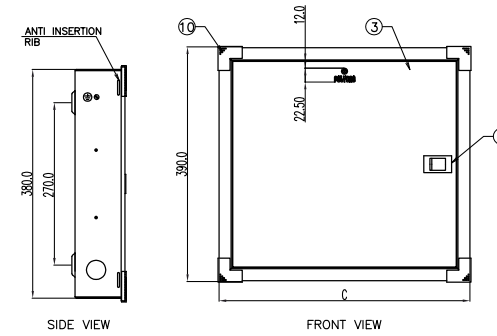
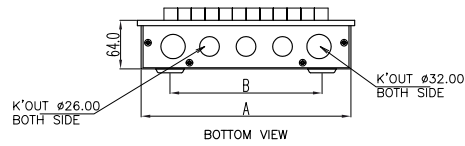

**GA DRAWINGS FOR -
TPN DB: IPN-30 (Single Door)**

| WAY | A | B | C | D | E |
|-----|-----|-----|-----|-----|-----|
| 04 | 263 | 188 | 273 | 72 | 72 |
| 04 | 335 | 260 | 345 | 72 | 144 |
| 06 | 371 | 296 | 381 | 108 | 144 |
| 08 | 407 | 332 | 417 | 144 | 144 |
| 12 | 551 | 476 | 561 | 216 | 144 |

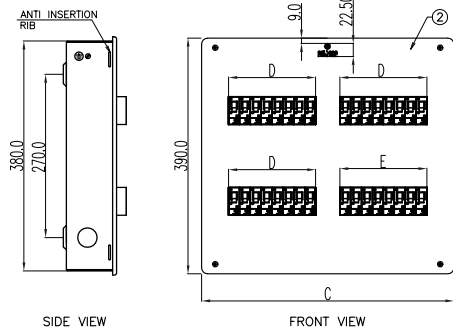
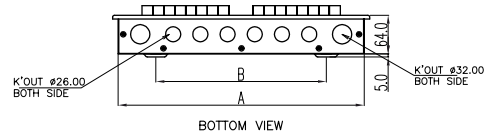

**GA DRAWINGS FOR -
SPN DB: IP-42 (Double Door)**

| WAY | A | B | C | D |
|-----|-----|-----|-----|-----|
| 4 | 136 | 62 | 146 | 72 |
| 6 | 172 | 92 | 182 | 108 |
| 8 | 208 | 128 | 218 | 144 |
| 10 | 244 | 164 | 254 | 180 |
| 12 | 280 | 200 | 290 | 216 |
| 16 | 352 | 272 | 362 | 288 |

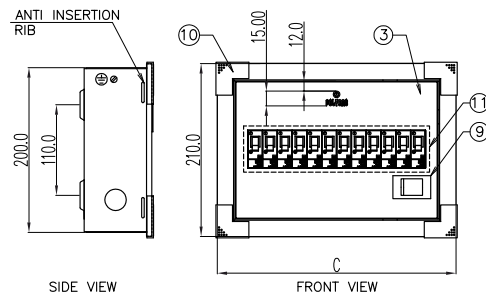
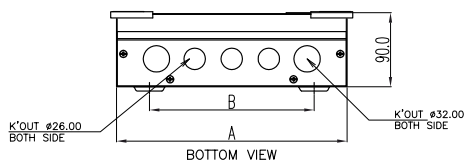

**GA DRAWINGS FOR -
TPN DB: IP-42 (Double Door)**

| WAY | A | B | C | D | E |
|-----|-----|-----|-----|-----|-----|
| 04 | 263 | 188 | 273 | 72 | 72 |
| 04 | 335 | 260 | 345 | 72 | 144 |
| 06 | 371 | 296 | 381 | 108 | 144 |
| 08 | 407 | 332 | 417 | 144 | 144 |
| 12 | 551 | 476 | 561 | 216 | 144 |

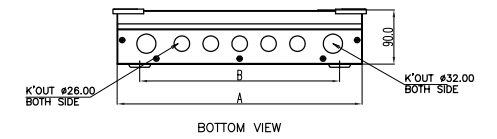

DB - Features

Conform IS 13032 / 8623
Adequate Knockout for wiring
Flush & Surface Mounting

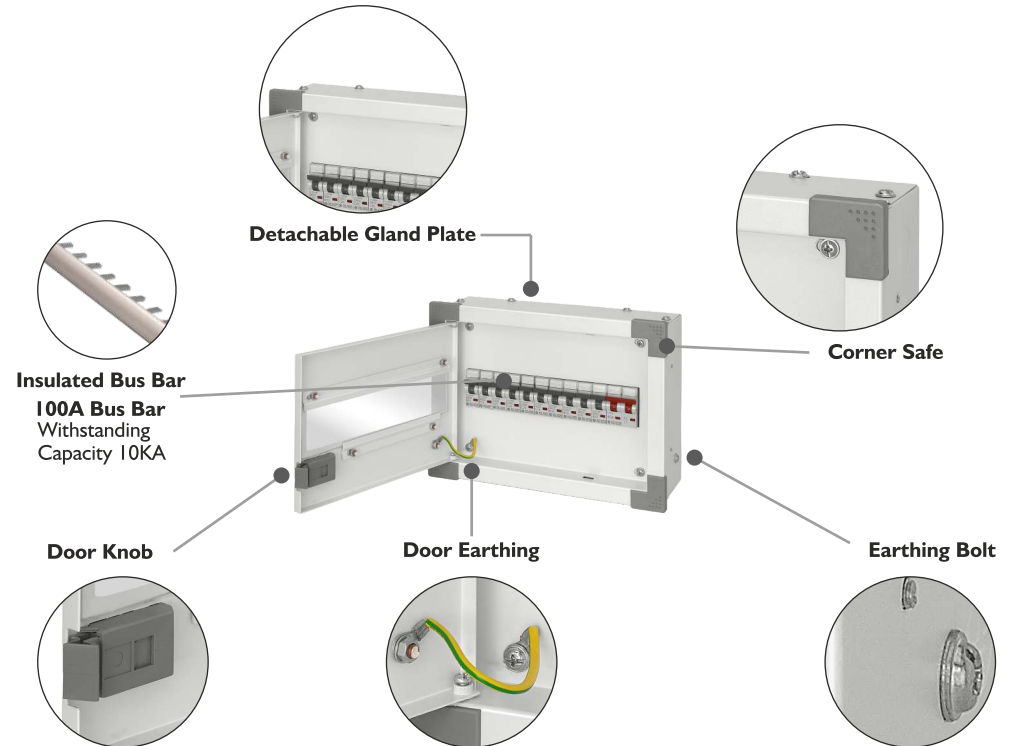

LEVANA

CURVE
SERIES

POLYCAB
Connection Zindagi Ka



Salient Features:

- Double rocker Mechanism-
Soundless soft touch
- FR Polycarbonate,
- Bimetal contacts with Silver Tip
- Also available with
touch and remote

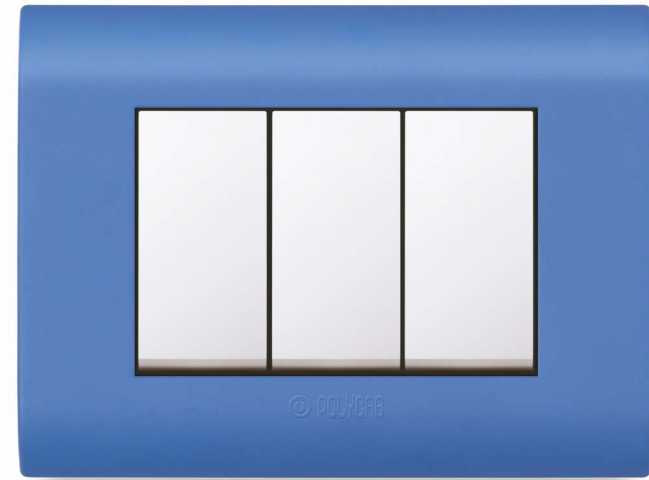

BLUE

CURVEPLATES



WHITE



MAGNESIUM GREY



BLUE

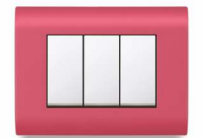

PINK

LEVANA
VALENCIA COVER PLATES



WHITE



BLACK

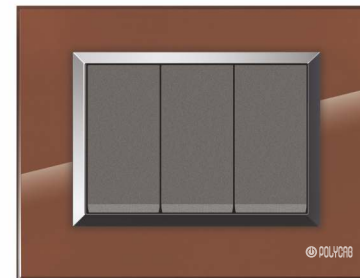

CHOCOLATE



RED



FROSTED MIRROR

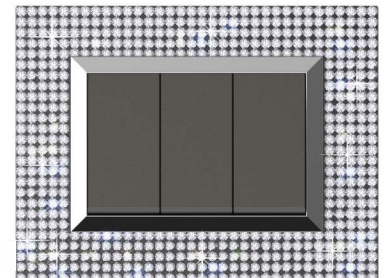

CRYSTAL

Salient Features:

- ▮ Double rocker Mechanism-
Soundless soft touch
- ▮ FR Polycarbonate,
- ▮ Bimetal contacts with Silver Tip
- ▮ Also available with
touch and remote



WHITE



CHAMPAGNE GOLD

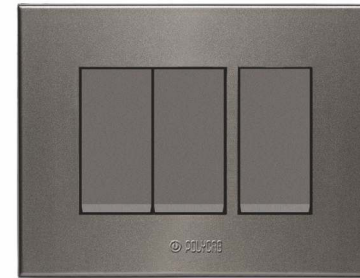

MAGNESIUM GREY

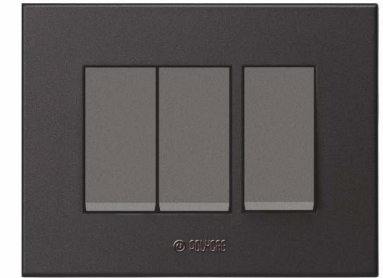

BLACK



NATURAL WOOD



AFRICAN WENGE

Salient Features:

- ▮ Double rocker Mechanism-
Soundless soft touch
- ▮ FR Polycarbonate,
- ▮ Bimetal contacts with Silver Tip
- ▮ Also available with
touch and remote

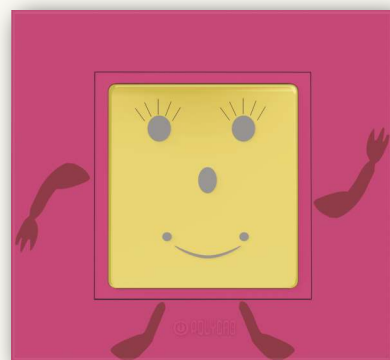
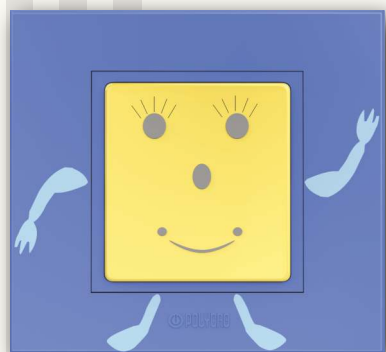

INTRODUCING
Kiddz
4 IN 1 FEATHER TOUCH
SWITCH



| Code | Item Description | Module | MRP/Unit ₹ | | Pkg. |
|---------------------------|-------------------------|--------|------------|-----------|----------|
| | | | White | Mag. Grey | |
| 10A / 16A SWITCHES | | | | | |
| SLV0100601/02 | 10A 1-way Switch | 1M | 105/- | 117/- | 20 / 400 |
| SLV0100701/02 | 10A 2-way Switch | 1M | 135/- | 148/- | 20 / 120 |
| SLV0100801/02 | 10A 1-way Switch w/ind. | 1M | 135/- | 148/- | 20 / 120 |
| SLV0100901/02 | 10A Bell Push | 1M | 136/- | 149/- | 20 / 120 |
| SLV0101001/02 | 10A Bell Push w/ind. | 1M | 152/- | 167/- | 20 / 120 |
| SLV0101101/02 | 16A 1-way Switch | 1M | 152/- | 167/- | 20 / 200 |
| SLV0101201/02 | 16A 2-way Switch | 1M | 197/- | 215/- | 20 / 120 |
| SLV0101301/02 | 16A 1-way Switch w/ind. | 1M | 197/- | 215/- | 20 / 200 |



| Code | Item Description | Module | MRP/Unit ₹ | | Pkg. |
|-------------------------------|-----------------------------|--------|------------|-----------|----------|
| | | | White | Mag. Grey | |
| 10A / 16A SWITCHES PRO | | | | | |
| SLV3100601/02 | 10A 1-Way Switch Pro | 1M | 105/- | 117/- | 20 / 400 |
| SLV3100701/02 | 10A 2-Way Switch Pro | 1M | 135/- | 148/- | 20 / 120 |
| SLV3100801/02 | 10A 1-Way Switch w/Ind. Pro | 1M | 135/- | 148/- | 20 / 120 |
| SLV3100901/02 | 10A Bell Push Pro | 1M | 136/- | 141/- | 20 / 120 |
| SLV3101001/02 | 10A Bell Push w/Ind. Pro | 1M | 152/- | 158/- | 20 / 120 |
| SLV3101101/02 | 16A 1-Way Switch Pro | 1M | 152/- | 167/- | 20 / 200 |
| SLV3101201/02 | 16A 2-Way Switch Pro | 1M | 197/- | 215/- | 20 / 120 |
| SLV3101301/02 | 16A 1-Way Switch w/Ind. Pro | 1M | 197/- | 215/- | 20 / 200 |



| Code | Item Description | Module | MRP/Unit ₹ | | Pkg. |
|---------------------------|----------------------------|--------|------------|-----------|----------|
| | | | White | Mag. Grey | |
| 10A / 16A SWITCHES | | | | | |
| SLV0101701/02 | 10A 1-way Switch w/ind. | 2M | 172/- | 190/- | 10 / 100 |
| SLV0102401/02 | 10A 2-way Switch | 2M | 172/- | 190/- | 10 / 100 |
| SLV0101901/02 | 10A Bell Push w/ind. | 2M | 178/- | 197/- | 10 / 100 |
| SLV0102001/02 | 16A 1-way Switch w/ind. | 2M | 229/- | 244/- | 10 / 100 |
| SLV0102301/02 | 32A DP 1-way Switch w/ind. | 2M | 310/- | 363/- | 10 / 100 |

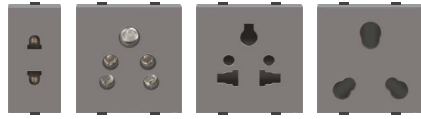

| Code | Item Description | Module | MRP/Unit ₹ | | Pkg. |
|----------------|--|--------|------------|-----------|----------|
| | | | White | Mag. Grey | |
| SOCKETS | | | | | |
| SLV0200101/02 | 6A 2-Pin Socket Outlet Euro | 1M | 104/- | 114/- | 20 / 120 |
| SLV0200201/02 | 6A 5-Pin Socket Outlet | 2M | 106/- | 115/- | 10 / 100 |
| SLV0200301/02 | 6A Socket Outlet-Multi | 2M | 149/- | 165/- | 10 / 200 |
| SLV0200501/02 | 6/16A Twin Socket Outlet Shutterd | 2M | 235/- | 255/- | 10 / 100 |
| SLV0200601/02 | 6/25 A Universal Socket | 2M | 288/- | 316/- | 10 / 100 |
| SLV0200701/02 | 6/16A Twin Socket Outlet Shutterd (for Glass Plates) | 2M | 248/- | 273/- | 10 / 100 |



| Code | Item Description | Module | MRP/Unit ₹ | | Pkg. |
|-------------------------------|-------------------------------|--------|------------|-----------|----------|
| | | | White | Mag. Grey | |
| DIMMER / FAN REGULATOR | | | | | |
| SLV0300101/02 | Dimmer 400w | 1 M | 306/- | 322/- | 10 / 100 |
| SLV0300201/02 | Dimmer 400w | 2 M | 446/- | 476/- | 10 / 100 |
| SLV0300301/02 | 4-Step 360-deg. Fan Regulator | 1 M | 414/- | 455/- | 10 / 100 |
| SLV0300401/02 | 5-Step 360-deg. Fan Regulator | 2 M | 489/- | 536/- | 10 / 100 |

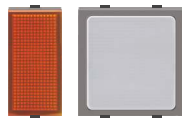

| Code | Item Description | Module | MRP/Unit ₹ | | Pkg. |
|------------------------------------|---------------------|--------|------------|-----------|----------|
| | | | White | Mag. Grey | |
| NEON INDICATOR / NIGHT LAMP | | | | | |
| SLV0300501 | Neon Indicator 230V | 1 M | 126/- | | 20 / 120 |
| SLV0300601/02 | Night Lamp 230V | 2 M | 347/- | 374/- | 10 / 60 |

| Code | Item Description | Module | MRP/Unit ₹ | | Pkg. |
|---|--------------------------|--------|------------|-----------|----------|
| | | | White | Mag. Grey | |
| BUZZER / FOOT-LIGHT / LED WITH SHRINK SLEEVE | | | | | |
| SLV0300701/02 | Electronic Buzzer 230V | 2 M | 252/- | 272/- | 10 / 60 |
| SLV0300801/02 | Foot-light w/3-LED 230V | 2 M | 359/- | 394/- | 10 / 60 |
| SLV0300900 | L.E.D With Shrink Sleeve | | 30/- | | 30 / 300 |



| Code | Item Description | Module | MRP/Unit ₹ | | Pkg. |
|---|------------------------------------|--------|------------|-----------|----------|
| | | | White | Mag. Grey | |
| TELEPHONE SOC. / CAT-5 / CAT-6 / TV SOCKET | | | | | |
| SLV0400101/02 | RJ-11 Telephone Socket Shutterd 2L | 1 M | 152/- | 167/- | 20 / 120 |
| SLV0400201/02 | RJ-11 Telephone socket 4L | 1 M | 186/- | 203/- | 20 / 120 |
| SLV0400301/02 | RJ-45 Krone Jack CAT-5 Shutterd | 1 M | 376/- | 409/- | 10 / 100 |
| SLV0400401/02 | RJ-45 Krone Jack CAT-6 Shutterd | 1 M | 665/- | 725/- | 10 / 100 |
| SLV0400501/02 | TV Co-axial Socket | 1 M | 142/- | 156/- | 20 / 120 |



| Code | Item Description | Module | MRP/Unit ₹ | | Pkg. |
|---|--|--------|------------|-----------|----------|
| | | | White | Mag. Grey | |
| DND TOUCH PANEL (INDOOR & OUTDOOR) / ELECTRONIC SWITCH | | | | | |
| SLV0500101/02 | Do Not Disturb Indicator Unit (Outside) | 1M | 138/- | 138/- | 20 / 120 |
| SLV0500701/02 | Make My Room Indicator Unit (Outside) | 1M | 138/- | 138/- | 20 / 120 |
| SLV0500801/02 | Pick My Laundry Indicator Unit (Outside) | 1M | 138/- | 138/- | 20 / 120 |
| SLV0500201/02 | Do Not Disturb Switch With LED (Inside) | 1M | 149/- | 162/- | 20 / 120 |
| SLV0500901/02 | Make My Room Switch With LED (Inside) | 1M | 149/- | 162/- | 20 / 120 |
| SLV0501001/02 | Pick My Laundry Switch With LED (Inside) | 1M | 149/- | 162/- | 20 / 120 |
| SLV0500501/02 | 25 A Electronic Switch With Card | 3M | 2231/- | 2360/- | 5 / 30 |
| SLV0500601 | Electronic Card Only | | 119/- | | |

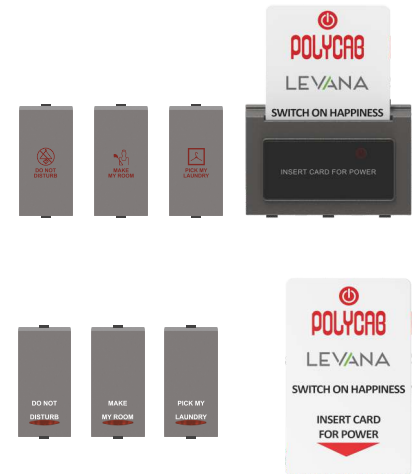

| Code | Item Description | Module | MRP/Unit ₹ | | Pkg. |
|--------------------|------------------|--------|------------|-----------|----------|
| | | | White | Mag. Grey | |
| BLANK PLATE | | | | | |
| SLV0800101/02 | Blank Plate | 1 M | 23/- | 30/- | 30 / 300 |



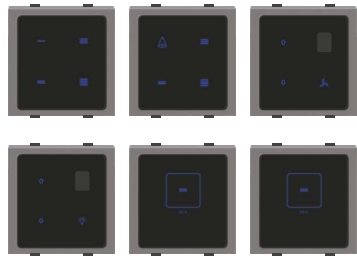
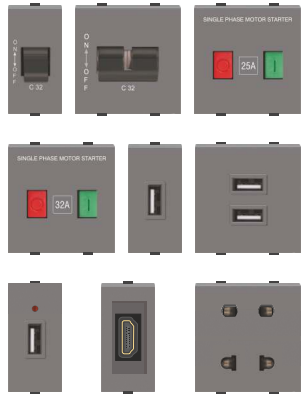

| Code | Item Description | Module | MRP/Unit ₹ | | Pkg. |
|---|--|--------|------------|-----------|----------|
| | | | White | Mag. Grey | |
| MINI MCBS / MOTOR STARTER SWITCH / USB CHARGER | | | | | |
| SLV0710601/02 | 6A 1P Mini MCB | 1M | 296/- | 328/- | 10 / 100 |
| SLV0711001/02 | 10A 1P Mini MCB | 1M | 296/- | 328/- | 10 / 100 |
| SLV0711601/02 | 16A 1P Mini MCB | 1M | 296/- | 328/- | 10 / 100 |
| SLV0712001/02 | 20A 1P Mini MCB | 1M | 296/- | 328/- | 10 / 100 |
| SLV0712501/02 | 25A 1P Mini MCB | 1M | 296/- | 328/- | 10 / 100 |
| SLV0713201/02 | 32A 1P Mini MCB | 1M | 296/- | 328/- | 10 / 100 |
| SLV0720601/02 | 6A 1P+N Mini MCB | 2M | 631/- | 695/- | 10 / 60 |
| SLV0721001/02 | 10A 1P+N Mini MCB | 2M | 631/- | 695/- | 10 / 60 |
| SLV0721601/02 | 16A 1P+N Mini MCB | 2M | 631/- | 695/- | 10 / 60 |
| SLV0722001/02 | 20A 1P+N Mini MCB | 2M | 631/- | 695/- | 10 / 60 |
| SLV0722501/02 | 25A 1P+N Mini MCB | 2M | 631/- | 695/- | 10 / 60 |
| SLV0723201/02 | 32A 1P+ N Mini MCB | 2M | 631/- | 695/- | 10 / 60 |
| SLV1022501/02 | 25A 1P+N Motor Starter Switch | 2M | 654/- | 714/- | 10 / 60 |
| SLV1023201/02 | 32A 1P+N Motor Starter Switch | 2M | 654/- | 714/- | 10 / 60 |
| SLV1800201/02 | 2A USB Charger 2000mA/5V | 2M | 1301/- | 1362/- | 10 / 60 |
| SLV1800401/02 | 2A USB Charger with Charging indication | 1M | 1222/- | 1344/- | 10/100 |
| SLV0400601/02 | HDMI Socket | 1M | 1228/- | 1350/- | 10/100 |
| SLV04L0601/02 | HDMI Socket - L Shape | 1M | 1228/- | 1350/- | 10/100 |
| SLV0400701/02 | Shaver Socket | 2M | 1473/- | 1620/- | 10/60 |
| IR TOUCH SCREEN SWITCH / FAN REGULATOR & LIGHT DIMMER /16A/30A | | | | | |
| SLV1400101/02 | 4 Switch IR Touch Screen | 2M | 5005/- | 5363/- | 5 / 30 |
| SLV1400201/02 | 3 Switch 1 Bell IR Touch Screen | 2M | 5005/- | 5363/- | 5 / 30 |
| SLV1400301/02 | Fan Regulator IR 8 Step Touch Screen | 2M | 5482/- | 5840/- | 5 / 30 |
| SLV1400401/02 | Light Dimmer IR 9 Step 300W Touch Screen | 2M | 5482/- | 5840/- | 5 / 30 |
| SLV1400501/02 | 16A Switch w/ind. IR Touch Screen | 2M | 4171/- | 4409/- | 5 / 30 |
| SLV1400601/02 | 30A Switch w/ind. IR Touch Screen | 2M | 4171/- | 4409/- | 5 / 30 |
| IR TOUCH SCREEN -DND/ CLEAN MY ROOM / BELL SWITCH/ REMOTE CONTROL | | | | | |
| SLV1400701/02 | DND/ Clean My Room Indicator With bell IR Touch Screen Outdoor | 2M | 4171/- | 4409/- | 5 / 30 |
| SLV1400801/02 | DND/ Clean My Room IR TouchScreen Indoor Unit | 2M | 4171/- | 4409/- | 5 / 30 |
| SLV1400901/02 | Bell Switch IR Touch Screen | 2M | 3575/- | 3814/- | 5 / 30 |
| SLV1401000 | Remote Control Unit Touch Pad | | | 1907/- | 5 / 30 |

| Code | Item Description | Module | MRP/Unit ₹ | | Pkg. |
|--|-------------------------------|--------|------------|--|--------|
| | | | White | | |
| 1/2/3/4 SWITCH AND 2 SWITCH 1 BELL TOUCH FEEL | | | | | |
| SLV1600102 | 1 Switch IR Touch Feel | 2M | 3551/- | | 5 / 30 |
| SLV1600202 | 2 Switch IR Touch Feel | 2M | 4171/- | | 5 / 30 |
| SLV1600302 | 4 Switch IR Touch Feel | 2M | 5363/- | | 5 / 30 |
| SLV1600402 | 3 Switch 1 Bell IR Touch Feel | 2M | 5363/- | | 5 / 30 |

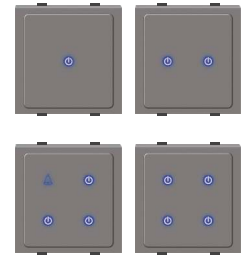

| FAN REGULATOR / LIGHT DIMMER TOUCH FEEL | | | | | |
|--|--|----|--------|--|--------|
| SLV1600502 | Fan Regulator 8 Step IR Touch Feel | 2M | 5840/- | | 5 / 30 |
| SLV1600602 | Light Dimmer 9 Step 300W IR Touch Feel | 2M | 5840/- | | 5 / 30 |
| SLV1600702 | 16A Switch w/ind. IR Touch Feel | 2M | 4409/- | | 5 / 30 |
| SLV1600802 | 30A Switch w/ind. IR Touch Feel | 2M | 4409/- | | 5 / 30 |
| SLV1600902 | Bell Switch IR Touch Feel | 2M | 3814/- | | 5 / 30 |

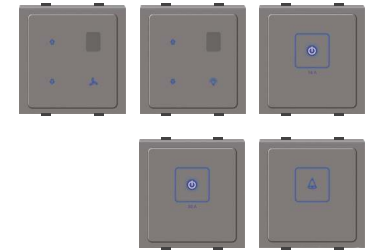

| KIDZ SWITCHES (for KIDS) | | | | | |
|---------------------------------|---|----|--------|--|--------|
| SLV16G1005 | Kids Smiley Switches (Pink-Girl) 4 IR Switch + 2M Plate | 2M | 6999/- | | 1 / 5 |
| SLV16G1006 | Kids Smiley Switches (Blue-Boy) 4 IR Switch + 2M Plate | 2M | 6999/- | | 1 / 5 |
| SLV1601005 | Smiley 4 IR Touch Switches-Pink | 2M | 6879/- | | 5 / 30 |
| SLV1601006 | Smiley 4 IR Touch Switches-Blue | 2M | 6879/- | | 5 / 30 |

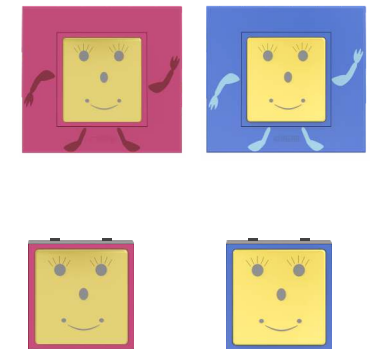

GLASS COVER PLATES (Available Colours)

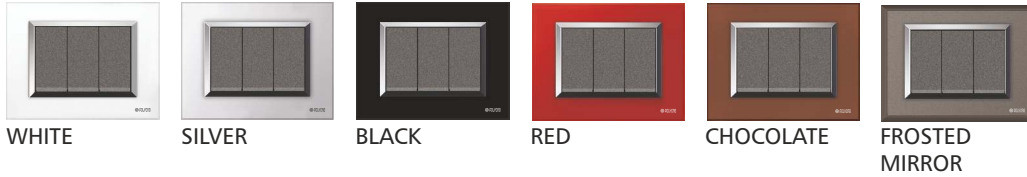

GLASS PLATES-FLAT (COLOURS)

| MODULES | 1M | 2M | 3M | 4M | 6M | 8M (H.) | 8M (Sq.) | 12M | 18M |
|-----------|------------|------------|------------|------------|------------|------------|------------|------------|------------|
| CODE | CODE | CODE | CODE | CODE | CODE | CODE | CODE | CODE | CODE |
| WHITE | SLV1100101 | SLV1100201 | SLV1100301 | SLV1100401 | SLV1100601 | SLV1100801 | SLV11S0801 | SLV1101201 | SLV1101801 |
| SILVER | SLV1100103 | SLV1100203 | SLV1100303 | SLV1100403 | SLV1100603 | SLV1100803 | SLV11S0803 | SLV1101203 | SLV1101803 |
| BLACK | SLV1100104 | SLV1100204 | SLV1100304 | SLV1100404 | SLV1100604 | SLV1100804 | SLV11S0804 | SLV1101204 | SLV1101804 |
| RED | SLV1100105 | SLV1100205 | SLV1100305 | SLV1100405 | SLV1100605 | SLV1100805 | SLV11S0805 | SLV1101205 | SLV1101805 |
| CHOCOLATE | SLV1100114 | SLV1100214 | SLV1100314 | SLV1100414 | SLV1100614 | SLV1100814 | SLV11S0814 | SLV1101214 | SLV1101814 |
| M.R.P ₹ | 595/- | 595/- | 775/- | 952/- | 1191/- | 1519/- | 1359/- | 1906/- | 2294/- |

GLASS PLATES-BEVELLED EDGE

| MODULES | 1M | 2M | 3M | 4M | 6M | 8M (H.) | 8M (Sq.) | 12M | 18M |
|---------|-------|-------|--------|--------|--------|---------|----------|--------|--------|
| CODE | CODE | CODE | CODE | CODE | CODE | CODE | CODE | CODE | CODE |
| M.R.P ₹ | 714/- | 833/- | 1107/- | 1360/- | 1701/- | 2170/- | 1941/- | 2722/- | 3277/- |

GLASS PLATES - BRONZE MIRROR

| MODULES | 1M | 2M | 3M | 4M | 6M | 8M (H.) | 8M (Sq.) | 12M | 18M |
|---------|-------|-------|--------|--------|--------|---------|----------|--------|--------|
| CODE | CODE | CODE | CODE | CODE | CODE | CODE | CODE | CODE | CODE |
| M.R.P ₹ | 833/- | 833/- | 1107/- | 1360/- | 1701/- | 2170/- | 1941/- | 2722/- | 3277/- |

GLASS PLATES - SILVER FROSTED MIRROR

| MODULES | 1M | 2M | 3M | 4M | 6M | 8M(H.) | 8M(Sq.) | 12M | 18M |
|---------|-------|-------|--------|--------|--------|--------|---------|--------|--------|
| CODES | CODE | CODE | CODE | CODE | CODE | CODE | CODE | CODE | CODE |
| M.R.P ₹ | 833/- | 833/- | 1107/- | 1360/- | 1701/- | 2170/- | 1941/- | 2722/- | 3277/- |

| | | | | | | | | | |
|------|--------|--------|--------|--------|--------|--------|--------|--------|--------|
| Pkg. | 5 / 60 | 5 / 60 | 5 / 60 | 5 / 40 | 5 / 30 | 5 / 20 | 5 / 20 | 5 / 20 | 5 / 15 |
|------|--------|--------|--------|--------|--------|--------|--------|--------|--------|

CRYSTAL PLATES

| MODULES | 1M | 2M | 3M | 4M | 6M | 8M (H.) | 8M (Sq.) | 12M | 18M |
|---------|------|------|------------|------|------------|---------|----------|------|------|
| CODE | CODE | CODE | CODE | CODE | CODE | CODE | CODE | CODE | CODE |
| WHITE | | | SLV2100301 | | SLV2100601 | | | | |
| GREY | | | SLV2100302 | | SLV2100602 | | | | |
| M.R.P ₹ | | | 7000/- | | 13000/- | | | | |

| | | | | | | | | | |
|-------------------|--------|--------|--------|--------|--------|--------|--------|--------|--------|
| Glass Plates Pkg. | 5 / 60 | 5 / 60 | 5 / 60 | 5 / 40 | 5 / 30 | 5 / 20 | 5 / 20 | 5 / 20 | 5 / 15 |
|-------------------|--------|--------|--------|--------|--------|--------|--------|--------|--------|

GLASS PLATES -SUPPORT FRAMES

| MODULES | 1M | 2M | 3M | 4M | 6M | 8M (H.) | 8M (Sq.) | 12M | 18M |
|---------|------|------|------|------|-------|---------|----------|-------|-------|
| CODE | CODE | CODE | CODE | CODE | CODE | CODE | CODE | CODE | CODE |
| M.R.P ₹ | 58/- | 58/- | 70/- | 79/- | 201/- | 244/- | 244/- | 332/- | 447/- |

| | | | | | | | | | |
|---------------------|----------|----------|----------|----------|--------|--------|--------|--------|--------|
| Support Plates Pkg. | 10 / 100 | 10 / 100 | 10 / 100 | 10 / 100 | 5 / 50 | 5 / 50 | 5 / 50 | 5 / 50 | 5 / 25 |
|---------------------|----------|----------|----------|----------|--------|--------|--------|--------|--------|

COVER PLATES (Available Colours)



GLOSSY WHITE WITH BLACK BASE

| MODULES | 1M | 2M | 3M | 4M | 6M | 8M (H.) | 8M (Sq.) | 12M | 16M | 18M |
|---------|------|------|-------|-------|-------|---------|----------|-------|-------|-------|
| CODE | CODE | CODE | CODE | CODE | CODE | CODE | CODE | CODE | CODE | CODE |
| M.R.P ₹ | 96/- | 96/- | 117/- | 140/- | 191/- | 244/- | 244/- | 289/- | 318/- | 351/- |

GLOSSY WHITE WITH WHITE BASE

| MODULES | 1M | 2M | 3M | 4M | 6M | 8M (H.) | 8M (Sq.) | 12M | 16M | 18M |
|---------|------|------|-------|-------|-------|---------|----------|-------|-------|-------|
| CODE | CODE | CODE | CODE | CODE | CODE | CODE | CODE | CODE | CODE | CODE |
| M.R.P ₹ | 96/- | 96/- | 117/- | 140/- | 191/- | 244/- | 244/- | 289/- | 318/- | 351/- |

COLOURS

| MODULES | 1M | 2M | 3M | 4M | 6M | 8M (H.) | 8M (Sq.) | 12M | 16M | 18M |
|----------------|------------|------------|------------|------------|------------|------------|------------|------------|------------|------------|
| CODE | CODE | CODE | CODE | CODE | CODE | CODE | CODE | CODE | CODE | CODE |
| MAGNESIUM GREY | SLV0900102 | SLV0900202 | SLV0900302 | SLV0900402 | SLV0900602 | SLV0900802 | SLV09S0802 | SLV0901202 | SLV0901602 | SLV0901802 |
| BLACK | SLV0900106 | SLV0900206 | SLV0900306 | SLV0900406 | SLV0900606 | SLV0900806 | SLV09S0806 | SLV0901206 | SLV0901606 | SLV0901806 |
| CHAMPAGNE Gold | SLV0900107 | SLV0900207 | SLV0900307 | SLV0900407 | SLV0900607 | SLV0900807 | SLV09S0807 | SLV0901207 | SLV0901607 | SLV0901807 |
| M.R.P ₹ | 147/- | 147/- | 191/- | 215/- | 276/- | 369/- | 369/- | 460/- | 490/- | 520/- |

WOODEN FINISH

| MODULES | 1M | 2M | 3M | 4M | 6M | 8M (H.) | 8M (Sq.) | 12M | 16M | 18M |
|---------------|------------|------------|------------|------------|------------|------------|------------|------------|------------|------------|
| CODE | CODE | CODE | CODE | CODE | CODE | CODE | CODE | CODE | CODE | CODE |
| AFRICAN WENGE | SLV0900108 | SLV0900208 | SLV0900308 | SLV0900408 | SLV0900608 | SLV0900808 | SLV09S0808 | SLV0901208 | SLV0901608 | SLV0901808 |
| TEAK WOOD | SLV0900109 | SLV0900209 | SLV0900309 | SLV0900409 | SLV0900609 | SLV0900809 | SLV09S0809 | SLV0901209 | SLV0901609 | SLV0901809 |
| NATURAL WOOD | SLV0900110 | SLV0900210 | SLV0900310 | SLV0900410 | SLV0900610 | SLV0900810 | SLV09S0810 | SLV0901210 | SLV0901610 | SLV0901810 |
| M.R.P ₹ | 183/- | 183/- | 244/- | 295/- | 398/- | 520/- | 520/- | 643/- | 674/- | 706/- |

| | | | | | | | | | | |
|------|----------|----------|----------|----------|--------|--------|--------|--------|--------|--------|
| Pkg. | 10 / 100 | 10 / 100 | 10 / 100 | 10 / 100 | 5 / 50 | 5 / 50 | 5 / 50 | 5 / 50 | 5 / 25 | 5 / 25 |
|------|----------|----------|----------|----------|--------|--------|--------|--------|--------|--------|

COVER PLATES (Available Colours)



WHITE



CHAMAGNE GOLD



MAGNESIUM GREY



MATT BLACK

ACACIA PLATE - WHITE

| MODULES | 1M | 2M | 3M | 4M | 6M | 8M(H.) | 8M(Sq.) | 12M | 18M |
|----------|------------|------------|------------|------------|------------|------------|------------|------------|------------|
| CODES | SLV1500101 | SLV1500201 | SLV1500301 | SLV1500401 | SLV1500601 | SLV1500801 | SLV15S0801 | SLV1501201 | SLV1501801 |
| M.R.P. ₹ | 155/- | 155/- | 195/- | 225/- | 315/- | 395/- | 395/- | 545/- | 725/- |

| | | | | | | | | | |
|------|--------|--------|--------|--------|--------|--------|--------|--------|--------|
| Pkg. | 5 / 60 | 5 / 60 | 5 / 60 | 5 / 40 | 5 / 30 | 5 / 20 | 5 / 20 | 5 / 20 | 5 / 15 |
|------|--------|--------|--------|--------|--------|--------|--------|--------|--------|

ACACIA PLATE - COLOUR

| MODULES | 1M | 2M | 3M | 4M | 6M | 8M(H.) | 8M(Sq.) | 12M | 18M |
|--------------|------------|------------|------------|------------|------------|------------|------------|------------|------------|
| CODE | CODE | CODE | CODE | CODE | CODE | CODE | CODE | CODE | CODE |
| MAG.GREY | SLV1500102 | SLV1500202 | SLV1500302 | SLV1500402 | SLV1500602 | SLV1500802 | SLV15S0802 | SLV1501202 | SLV1501802 |
| MATT. BLACK | SLV1500103 | SLV1500203 | SLV1500303 | SLV1500403 | SLV1500603 | SLV1500803 | SLV15S0803 | SLV1501203 | SLV1501803 |
| CHAMP. GOLD | SLV1500104 | SLV1500204 | SLV1500304 | SLV1500404 | SLV1500604 | SLV1500804 | SLV15S0804 | SLV1501204 | SLV1501804 |
| MOSS GREEN | SLV1500105 | SLV1500205 | SLV1500305 | SLV1500405 | SLV1500605 | SLV1500805 | SLV15S0805 | SLV1501205 | SLV1501805 |
| GREY GRANITE | SLV1500106 | SLV1500206 | SLV1500306 | SLV1500406 | SLV1500606 | SLV1500806 | SLV15S0806 | SLV1501206 | SLV1501806 |
| M.R.P. ₹ | 190/- | 190/- | 230/- | 225/- | 275/- | 475/- | 475/- | 675/- | 870/- |

| | | | | | | | | | |
|------|--------|--------|--------|--------|--------|--------|--------|--------|--------|
| Pkg. | 5 / 60 | 5 / 60 | 5 / 60 | 5 / 40 | 5 / 30 | 5 / 20 | 5 / 20 | 5 / 20 | 5 / 15 |
|------|--------|--------|--------|--------|--------|--------|--------|--------|--------|

ACACIA PLATE - WOODEN FINISH

| MODULES | 1M | 2M | 3M | 4M | 6M | 8M(H.) | 8M(Sq.) | 12M | 18M |
|--------------|------------|------------|------------|------------|------------|------------|------------|------------|------------|
| CODE | CODE | CODE | CODE | CODE | CODE | CODE | CODE | CODE | CODE |
| CAROLINA OAK | SLV1500107 | SLV1500207 | SLV1500307 | SLV1500407 | SLV1500607 | SLV1500807 | SLV15S0807 | SLV1501207 | SLV1501807 |
| M.R.P. ₹ | 250/- | 250/- | 320/- | 380/- | 510/- | 630/- | 630/- | 880/- | 1200/- |

| | | | | | | | | | |
|------|--------|--------|--------|--------|--------|--------|--------|--------|--------|
| Pkg. | 5 / 60 | 5 / 60 | 5 / 60 | 5 / 40 | 5 / 30 | 5 / 20 | 5 / 20 | 5 / 20 | 5 / 15 |
|------|--------|--------|--------|--------|--------|--------|--------|--------|--------|

COVER PLATES (Available Colours)

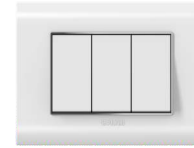

WHITE

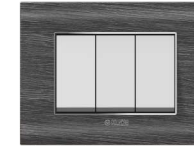

DARK OAK

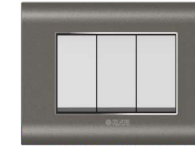

MAGNESIUM GREY

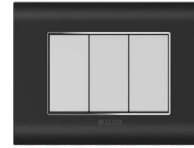

WHITE BLACK

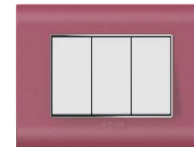

CERISE PINK

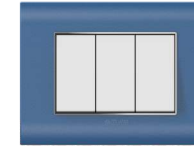

DANUBE BLUE

CURVE PLUS - WHITE

| MODULES | 1M | 2M | 3M | 3M / PARTITION | 4M | 6M | 8M(H.) | 8M(Sq.) | 12M | 18M |
|----------|------------|------------|------------|----------------|------------|------------|------------|------------|------------|------------|
| CODES | SLV3200101 | SLV3200201 | SLV3200301 | SLV32P0301 | SLV3200401 | SLV3200601 | SLV3200801 | SLV32S0801 | SLV3201201 | SLV3201801 |
| M.R.P. ₹ | 110/- | 110/- | 130/- | 130/- | 155/- | 230/- | 280/- | 280/- | 375/- | 450/- |

| | | | | | | | | | | |
|------|----------|----------|----------|----------|----------|--------|--------|--------|--------|--------|
| Pkg. | 10 / 100 | 10 / 100 | 10 / 100 | 10 / 100 | 10 / 100 | 5 / 50 | 5 / 50 | 5 / 50 | 5 / 50 | 5 / 25 |
|------|----------|----------|----------|----------|----------|--------|--------|--------|--------|--------|

CURVE PLUS - COLOUR

| MODULES | 1M | 2M | 3M | 3M / PARTITION | 4M | 6M | 8M(H.) | 8M(Sq.) | 12M | 18M |
|-------------|------------|------------|------------|----------------|------------|------------|------------|------------|------------|------------|
| CODE | CODE | CODE | CODE | CODE | CODE | CODE | CODE | CODE | CODE | CODE |
| MAG.GREY | SLV3200102 | SLV3200202 | SLV3200302 | SLV32P0302 | SLV3200402 | SLV3200602 | SLV3200802 | SLV32S0802 | SLV3201202 | SLV3201802 |
| CHAMP. GOLD | SLV3200103 | SLV3200203 | SLV3200303 | SLV32P0303 | SLV3200403 | SLV3200603 | SLV3200803 | SLV32S0803 | SLV3201203 | SLV3201803 |
| MATT. BLACK | SLV3200104 | SLV3200204 | SLV3200304 | SLV32P0304 | SLV3200404 | SLV3200604 | SLV3200804 | SLV32S0804 | SLV3201204 | SLV3201804 |
| CERISE PINK | SLV3200105 | SLV3200205 | SLV3200305 | SLV32P0305 | SLV3200405 | SLV3200605 | SLV3200805 | SLV32S0805 | SLV3201205 | SLV3201805 |
| CRIMSON RED | SLV3200106 | SLV3200206 | SLV3200306 | SLV32P0306 | SLV3200406 | SLV3200606 | SLV3200806 | SLV32S0806 | SLV3201206 | SLV3201806 |
| DANUBE BLUE | SLV3200108 | SLV3200208 | SLV3200308 | SLV32P0308 | SLV3200408 | SLV3200608 | SLV3200808 | SLV32S0808 | SLV3201208 | SLV3201808 |
| M.R.P. ₹ | 160/- | 160/- | 210/- | 210/- | 225/- | 325/- | 385/- | 385/- | 490/- | 575/- |

| | | | | | | | | | | |
|------|----------|----------|----------|----------|----------|--------|--------|--------|--------|--------|
| Pkg. | 10 / 100 | 10 / 100 | 10 / 100 | 10 / 100 | 10 / 100 | 5 / 50 | 5 / 50 | 5 / 50 | 5 / 50 | 5 / 25 |
|------|----------|----------|----------|----------|----------|--------|--------|--------|--------|--------|

CURVE PLUS - COLOUR

| MODULES | 1M | 2M | 3M | 3M / PARTITION | 4M | 6M | 8M(H.) | 8M(Sq.) | 12M | 18M |
|----------|------------|------------|------------|----------------|------------|------------|------------|------------|------------|------------|
| CODE | CODE | CODE | CODE | CODE | CODE | CODE | CODE | CODE | CODE | CODE |
| DARK OAK | SLV3200107 | SLV3200207 | SLV3200307 | SLV32P0307 | SLV3200407 | SLV3200607 | SLV3200807 | SLV32S0807 | SLV3201207 | SLV3201807 |
| M.R.P. ₹ | 190/- | 190/- | 250/- | 250/- | 310/- | 410/- | 500/- | 500/- | 680/- | 850/- |

| | | | | | | | | | | |
|------|----------|----------|----------|----------|----------|--------|--------|--------|--------|--------|
| Pkg. | 10 / 100 | 10 / 100 | 10 / 100 | 10 / 100 | 10 / 100 | 5 / 50 | 5 / 50 | 5 / 50 | 5 / 50 | 5 / 25 |
|------|----------|----------|----------|----------|----------|--------|--------|--------|--------|--------|

CURVE PLATES (Available Colours)

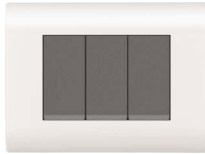

WHITE

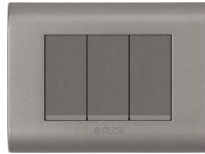

MAGNESIUM GREY

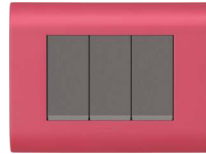

PINK

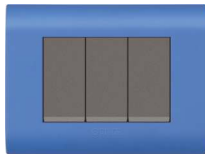

BLUE

| CURVE - WHITE | | | | | | | | | | |
|---------------|------------|------------|------------|---------------|------------|------------|------------|------------|------------|------------|
| MODULES | 1M | 2M | 3M | 3M /PARTITION | 4M | 6M | 8M (H.) | 8M (Sq.) | 12M | 18M |
| CODE | SLV0900113 | SLV0900213 | SLV0900313 | SLV09P0314 | SLV0900413 | SLV0900613 | SLV0900813 | SLV09S0813 | SLV0901213 | SLV0901813 |
| M.R.P. ₹ | 96/- | 96/- | 117/- | 117/- | 140/- | 191/- | 244/- | 244/- | 289/- | 351/- |

| CURVE - COLOUR | | | | | | | | | | |
|----------------|------------|------------|-----------|---------------|------------|------------|------------|------------|------------|------------|
| MODULES | 1M | 2M | 3M | 3M /PARTITION | 4M | 6M | 8M (H.) | 8M (Sq.) | 12M | 18M |
| CODE | CODE | CODE | CODE | CODE | CODE | CODE | CODE | CODE | CODE | CODE |
| MAGNESIUM | | | | | | | | | | |
| GREY | SLV3109102 | SLV3109202 | SLV319302 | SLV319P302 | SLV3109402 | SLV3109602 | SLV3109802 | SLV319S802 | SLV3109122 | SLV3109182 |
| PINK | SLV3109103 | SLV3109203 | SLV319303 | SLV319P303 | SLV3109403 | SLV3109603 | SLV3109803 | SLV319S803 | SLV3109123 | SLV3109183 |
| BLUE | SLV3109104 | SLV3109204 | SLV319304 | SLV319P304 | SLV3109404 | SLV3109604 | SLV3109804 | SLV319S804 | SLV3109124 | SLV3109184 |
| M.R.P. ₹ | 147/- | 147/- | 191/- | 191/- | 215/- | 313/- | 369/- | 369/- | 460/- | 520/- |
| Pkg. | 10/100 | 10/100 | 10/100 | 10/100 | 10/100 | 5/50 | 5/50 | 5/50 | 5/50 | 5/25 |

THE MAGIC OF
TECHNOLOGY



Glowing LED Switch

Brighten your spaces with these glow-in-the-dark switches. The plates of these switches are designed with the provision of L.E.D., to glow like recessed downlights and create soothing ambience, additionally helping you locate switch boards in dark.

These L.E.D.s can also be connected to our Dusk/Dawn sensors, so they glow automatically in the dark, and turn off automatically in bright light.

GLASS COVER PLATES (Available Sizes, DIMENSION IN mm)

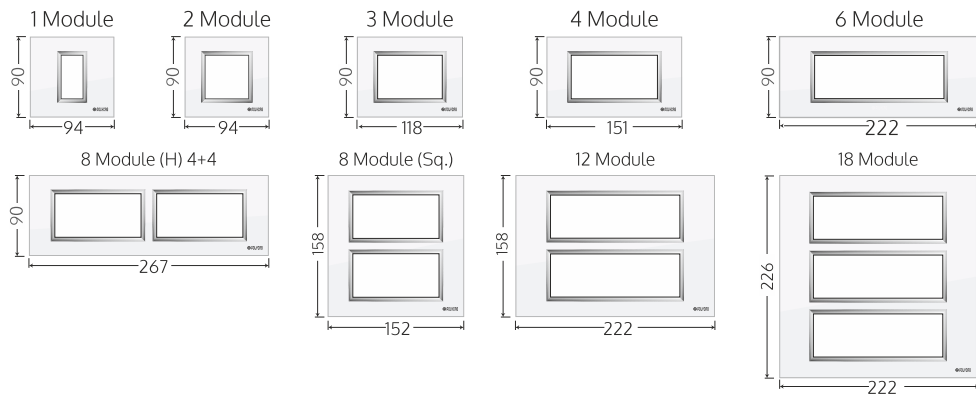

CAPRINA SERIES

COVER PLATES WITH MOUNTING PLATES
(Available Sizes, DIMENSION IN mm)

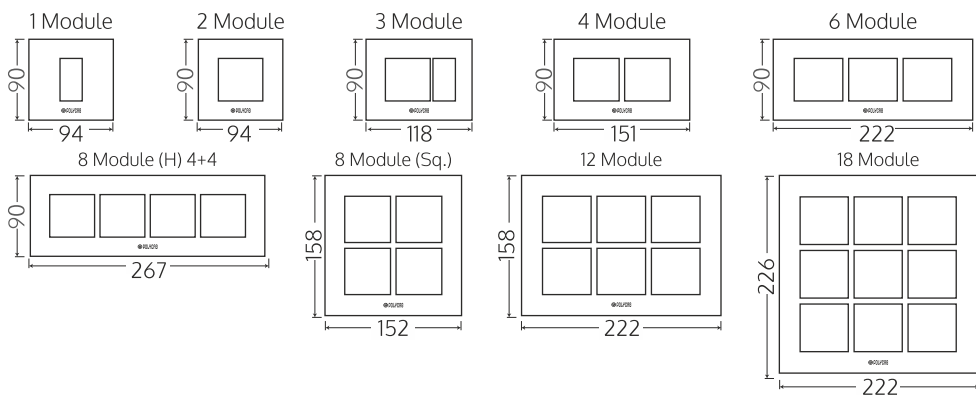

SUPPORT FRAMES HORIZONTAL & VERTICAL FOR FIXING (DIMENSION IN mm)

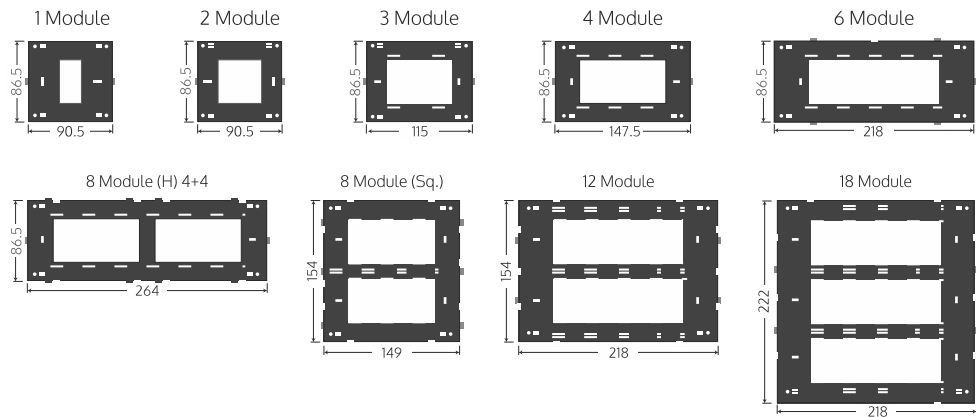

Code Item Description Cat. No. MRP/Unit ₹ Pkg.

CONCEALED METAL BOX

| | | | |
|------------|-----------------------------|-------|----------|
| SMB0100073 | 1&2M Concealed Metal Box | 64/- | 10 / 150 |
| SMB0100074 | 3M Concealed Metal Box | 90/- | 10 / 100 |
| SMB0100075 | 4M Concealed Metal Box | 108/- | 10 / 80 |
| SMB0100076 | 6M Concealed Metal Box | 148/- | 10 / 60 |
| SMB0100077 | 8M Sq. Concealed Metal Box | 194/- | 5 / 40 |
| SMB0100081 | 8M Hor. Concealed Metal Box | 194/- | 5 / 50 |
| SMB0100079 | 12M Concealed Metal Box | 237/- | 5 / 30 |
| SMB0100082 | 16M Concealed Metal Box | 260/- | 5 / 20 |
| SMB0100080 | 18M Concealed Metal Box | 292/- | 5 / 20 |



- Salient Features :**
- High Durability • Corrosion Resistant
 - With Earthing Terminal

CONCEALED PLASTIC BOX

| | | | |
|------------|-------------------------------|-------|----------|
| SPB0100065 | 1&2M Concealed Plastic Box | 43/- | 10 / 160 |
| SPB0100066 | 3M Concealed Plastic Box | 48/- | 10 / 160 |
| SPB0100067 | 4M Concealed Plastic Box | 63/- | 10 / 160 |
| SPB0100068 | 6M Concealed Plastic Box | 98/- | 10 / 120 |
| SPB0100069 | 8M Sq. Concealed Plastic Box | 124/- | 5 / 80 |
| SPB0100070 | 8M Hor. Concealed Plastic Box | 124/- | 5 / 80 |
| SPB0100071 | 12M Concealed Plastic Box | 158/- | 5 / 60 |
| SPB0100072 | 18M Concealed Plastic Box | 202/- | 5 / 60 |



SURFACE MOUNTING PLASTIC BOX

| | | | |
|------------|--------------------------------------|-------|----------|
| SPB0200057 | 1&2M Surface Mounting Plastic Box | 57/- | 10 / 160 |
| SPB0200058 | 3M Surface Mounting Plastic Box | 70/- | 10 / 160 |
| SPB0200059 | 4M Surface Mounting Plastic Box | 80/- | 10 / 160 |
| SPB0200060 | 6M Surface Mounting Plastic Box | 104/- | 10 / 120 |
| SPB0200100 | 8M Sq. Surface Mounting Plastic Box | 145/- | 5 / 80 |
| SPB0200062 | 8M Hor. Surface Mounting Plastic Box | 145/- | 5 / 80 |
| SPB0200101 | 12M Surface Mounting Plastic Box | 186/- | 5 / 60 |
| SPB0200064 | 18M Surface Mounting Plastic Box | 242/- | 5 / 60 |



Experience
precision
with
Innovation
Accessories



| Code | Item Description | MRP ₹ Per Unit | Pkg. |
|------------|--|-------------------|----------|
| SAC0200004 | 16A 3-PIN PLUG ISI | 84/- | 20 / 160 |
| SAC0200003 | 06A 3-PIN PLUG ISI | 55/- | 20 / 240 |
| SAC0100001 | 4-WAY EXTENSION BOARD 4 universal-socket outlet + 1 switch / indicator / cord Length 1.5 meter | 575/- | 1 / 10 |
| SAC0100002 | 4-WAY EXTENSION BOARD 4 universal-socket outlet + 2 USB 500ma 5v with 1 switch / indicator / cord-Length 1.5meter | 825/- | 1 / 10 |
| SLV1900101 | ANGLED / BATTEN BULBHOLDER LEVANA | 70/- | 20 / 400 |
| SLV2000301 | JUMBO CEILING ROSE 3T LEVANA | 42/- | 20 / 400 |
| SLV2000201 | JUMBO CEILING ROSE 2T LEVANA | 35/- | 20 / 400 |
| SLV1700100 | Wireless Door Bell with Bluetooth Speaker (Indoor & Outdoor unit) NEW | 5150/- | 1 / 5 |



4-WAY EXTENSION BOARD



3PIN PLUG TOP



ANGLED / BATTEN BULB HOLDER



JUMBO CEILING ROSE



36 POLYCAB Switches & Switchgear

WARRANTY POLICY

| | |
|---|------------|
| MCB's | 36 Months |
| RCCB's & RCBO's | 36 Months |
| DB's | 12 Months |
| LEVANA Switches & Socket | 120 Months |
| Electronic wiring product (viz Dimmers, Step Fan Regulators, Moter Starters, Indicator, Buzzers RJ45,RJ11 & TV sockets) | 24 Months |
| Automation and Accessories | 12 Months |

Polycab's Products carry a warranty against manufacturing defects, subject to use of the Product for the right application with correct wiring/connection and normal operating conditions.



POLYCAB

CARE

Your Happiness, Our Passion.

• Cables & Wires • Lighting & Luminaires • Switches & Switchgears • Fans & Appliances • uPVC Conduits & Fittings
• Cable Glands & Lugs • Solar • Pump • Cable Tray

Email: customercare@polycab.com

Toll Free No.: 1800 267 0008

• Working Days: Monday to Saturday • Timings: 9:00 AM to 6:00 PM

Terms and Conditions:

The prices are inclusive of all Government levies. • Goods are despatched by us on purchaser's risk. • All claims for loss, damage or shortage will be filed by the purchaser directly with carriers. • Disputes, if any are subject to Mumbai jurisdiction only. • Price are subject to change without notice. • MRP mentioned is for per unit & in Indian Rupees • Due to continuous technology upgrades the design & specifications may vary without notice.